

EZ90-199N DIRECT SPARK BURNER PARTS BREAKDOWN

Water heater parts and control panel parts are listed on their own **Parts Finders**.

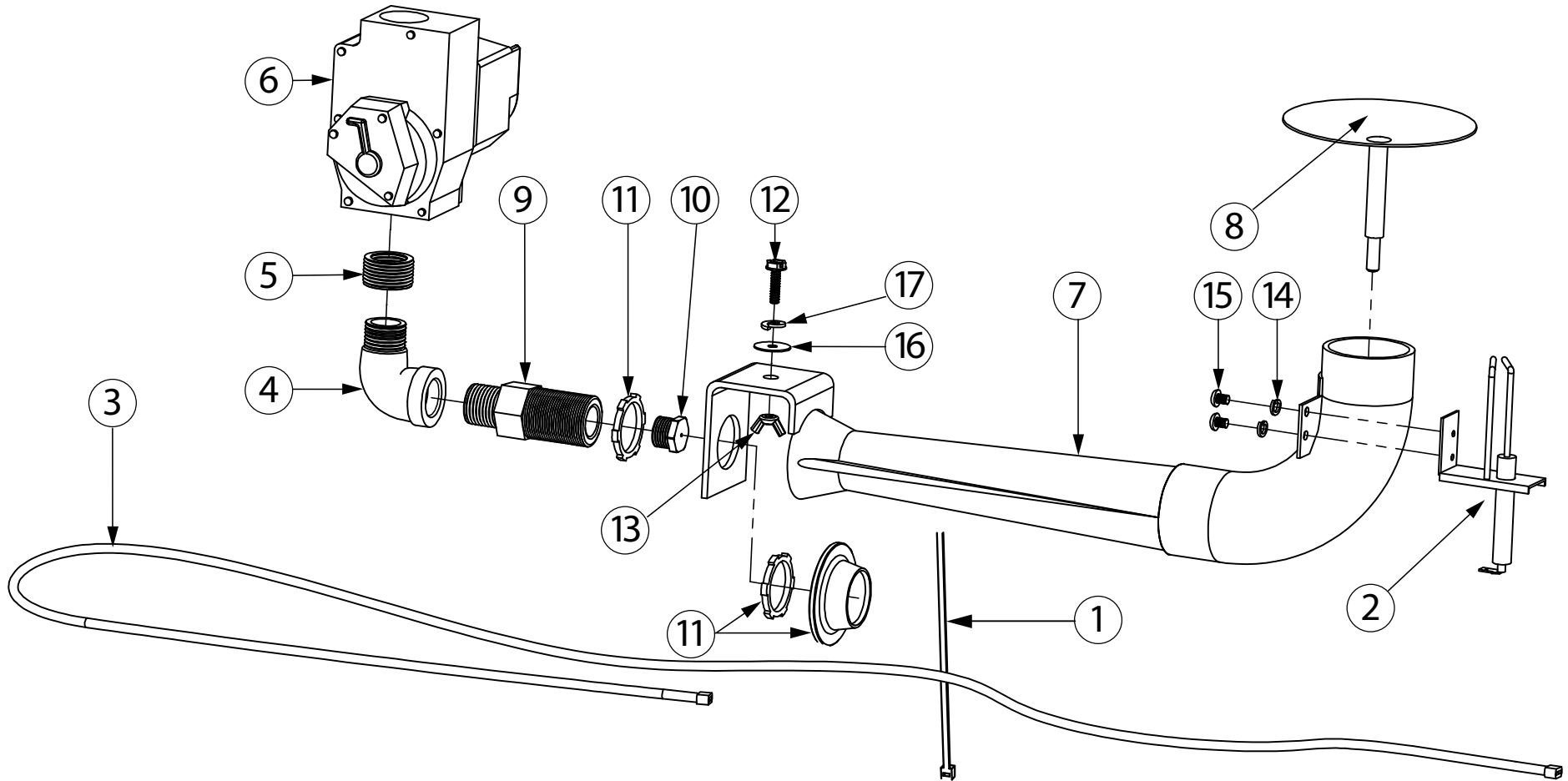

#	Item #	Description	#	Item #	Description
1	17347	Zip Tie, 7.5" UL94V-0	10	20090	Orifice
2	20027	Igniter, Direct, ezFIT PSE-BK1	11	20100	Air Deflector w/2 Lock Nuts
3	20029	Ignition Cable	12	25010	Bolt, SLT Hex Washer, 10-24 x 3/4"
4	20030	90° Elbow, 1/2" MNPT x 1/2" FNPT	13	25012	Wing Nut, 10-24
5	20035	Reducer, 3/4" MNPT x 1/2" FNPT	14	25087	Lock Washer, #10
6	20041	Gas Valve, Natural Gas, VR8305P4279	15	25110	Screw, Button Head, 10-32 x 1/4"
7	20066	Burner 120M Venturi, 15"	16	25120	Washer, Zinc, 3/16" x 3/4"
8	20076	Flame Spreader, 6"	17	25102	Lock Washer, Zinc, 1/4"
9	20085	Orifice Holder			