

100HEC-250 Parts Breakdown

#	Item #	Description
1	32065	224-32758-30 Magnesium Anode Rod
2	32060	239-82034-00 Lower Temperature Sensor
2	32085	239-82033-00 Upper Temperature Sensor
3	32110	230-33630-04 T&P Valve
4	35107	239-43211-00 Condensate Tee
5	32105	239-46037-01 Exhaust Pressure Switch
6	32125	239-43238-02 Resettable Limit Switch
7	32175	205-18428-00 Cleanout Cover
8	32070	205-18427-00 Cleanout Gasket
9	32075	205-32942-00 Cleanout Gasket - ASME
10	32180	205-32941-00 Cleanout Cover - ASME
11	32185	229-44375-00 Hydrojet Inlet Tube
12	35105	239-4406-01 3" Concentric Vent Terminal
13	32115	233-82054-00 Potentiometer Temp Control
14	32120	239-43235-00 Temperature Control Knob
15A	32150	233-46045-00 Electronic Control Module
15B	32165	239-44724-01 Vacuum Switch Intake (Prior to S/N CE7818523)
15C	32155	233-41346-00 Thermostat Board
15D	32160	233-43346-00 Transformer
16A	32135	265-43229-00 Blower
16B	32020	265-43232-00 Flame Sensor w/Gasket
16C	32130	265-45543-00 Hot Surface Ign. w/Gasket
16D	32215	243-46007-03 Gas Valve Assembly - NG (S/N CH8129547 & After)
16D	32216	243-43368-03 Gas Valve Assembly - NG (Prior to CH8129547)
16D	32225	243-46008-03 Gas Valve Assembly - LP (S/N CH8129547 & After)
16D	32230	243-43757-03 Gas Valve Assembly - LP (Prior to CH8129547)
16E	32250	265-46019-00 Burner Tube w/Gasket
16F	32255	239-44654-00 Gas Venturi to Blower
16G	32270	239-43201-00 Weldment-Blower Transition
16H	32275	239-43246-00 Burner Mounting Gasket
16I	32280	239-43167-00 Burner Mounting Insert
16J	32285	239-43197-00 Gasket-Burner Mntg Insert

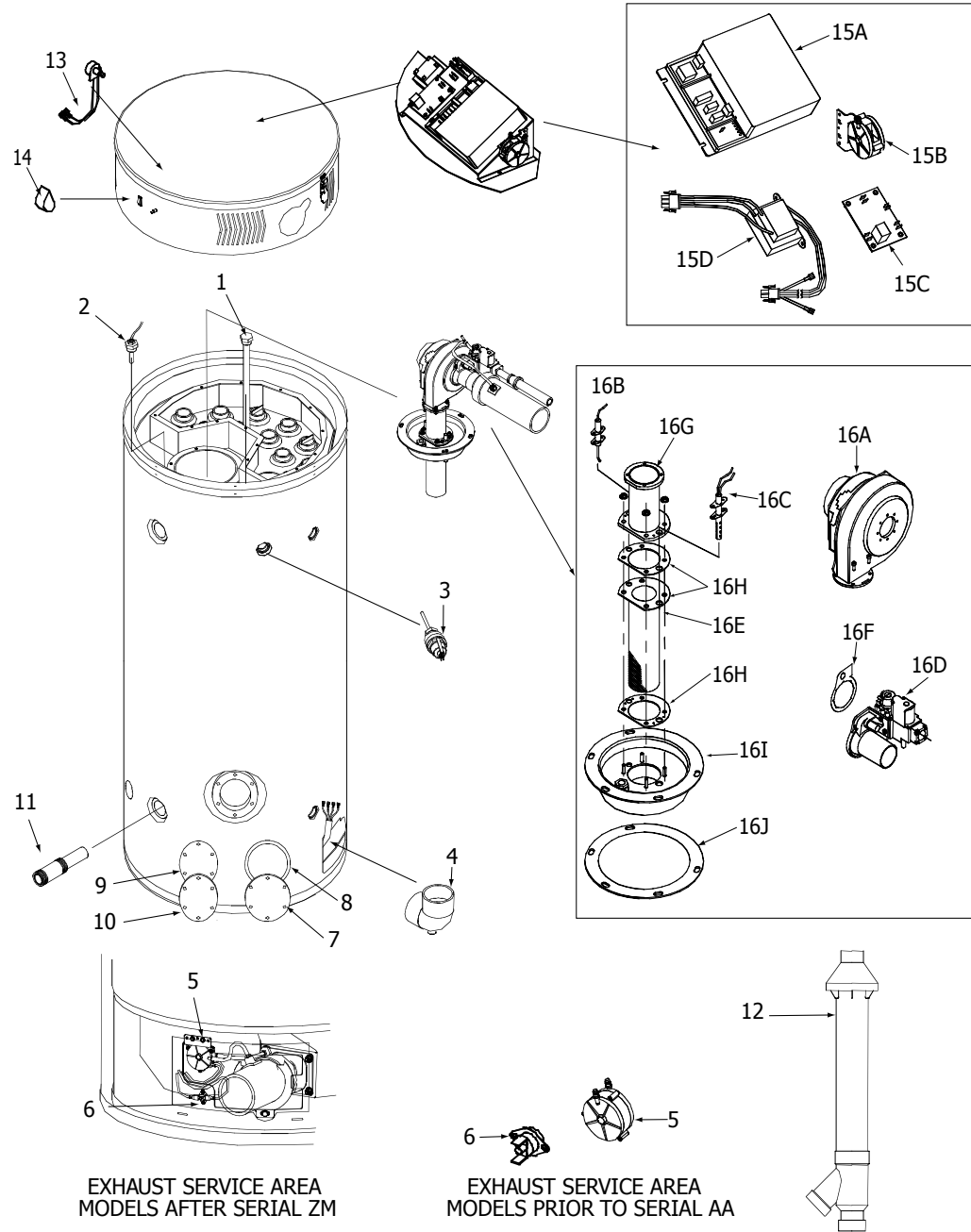

#	Item #	Optional Equipment
Opt	32190	224-38508-07 Aluminium Anode Rod
Opt	32090	224-46075-00 Power Anode Rod